

H4053



GoSmart Outdoor Battery Camera IP-200 / IP-210 SNAP with Wi-Fi



Table of Contents

Safety instructions and warnings	2
Contents of the package	3
Technical Specifications	4
Description of the device	5
Installation and assembly	6
Controls and functions	11
Troubleshooting FAQ	12

Safety instructions and warnings



Before using the device, read the instructions for use.



Observe the safety instructions in this manual.



Do not dispose of electrical appliances as unsorted municipal waste, use sorted waste collection points. Contact your local authority for up-to-date information on collection points. If electrical appliances are disposed of in landfill sites, hazardous substances may leach into groundwater and get into the food chain and harm your health.

Do not use water or chemicals to clean dirt from the outside of the device. Always use a dry cloth to prevent mechanical damage and electric shock.

Do not connect the power cord to the power outlet with wet or damp hands, as there is a risk of electric shock.

Do not disassemble, repair or modify the equipment yourself. Doing so may result in fire, electric shock or permanent damage.

EMOS spol. s r.o. declares that the products H4053, H4063 are in conformity with the essential requirements and other relevant provisions of the directives. The equipment can be operated freely in the EU.

The Declaration of Conformity can be found on the website <http://www.emos.eu/download>.

The equipment can be operated on the basis of general authorisation No. VO-R/10/07.2021-8 as amended.



Contents of the package
Camera unit
Power adapter
USB cable
Magnetic mount
Swivel mount
Screw set
Manual





Technical specifications

Power supply: DC 5 V/1 A

Dimensions: 58 × 58 × 94 mm

Net weight: 225 g

Resolution: H4053 - 1 920 × 1 080 /

H4063 - 2 592 × 1 944

Sensor: H4053 - 1/2.9" 2 Megapixel CMOS /

H4063 - 1/2.7" 5 Megapixel CMOS

Battery capacity: 9 000 mAh

PIR detection range: 9 m PIR

angle: 120°

Lens: 3.2 mm, F2.0

Storage: SD card (max. 128 GB, FAT32), Cloud storage

Degree of protection: IP65

APP: EMOS GoSmart for Android and iOS

Connectivity: 2.4 GHz Wi-Fi (IEEE802.11b/g/n)

Frequency band: 2.400-2.4835 GHz Maximum number of users: 4



Description of the device

- 1 - PIR sensor
- 2 - Lens
- 3 - Status light
 - The LED is red : the network settings are not correct .
 - The LED flashes red: the camera is preparing to connect to a Wi-Fi network.
 - The LED flashes red quickly: you are now connecting to a Wi-Fi network.
 - The LED is blue: the camera is working properly.
- 4 - Light sensor (Used to distinguish between day and night)
- 5 - Microphone
- 6 - Speaker
- 7 - Place for attaching the magnetic holder
- 8 - Waterproof cover for charging port and control buttons. Smaller inner cover can be opened, power cable can be connected and IP protection is maintained even during charging.

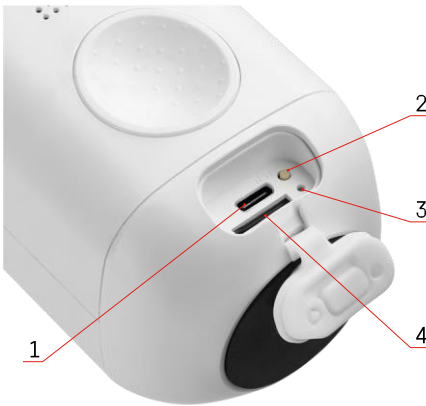

- 1 - Charging Port
- 2 - Reset button - Press the RESET button for 5 seconds to reset the unit to factory settings.
- 3 - Charging light:
 - The LED is red: the battery is charging.
 - The LED is blue: charging is complete.
- 4 - SD card slot

Notice

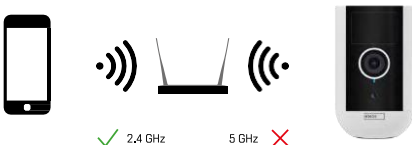

The camera only supports 2.4GHz Wi-Fi (does not support 5GHz).

Installation and assembly

Installing the magnetic holder

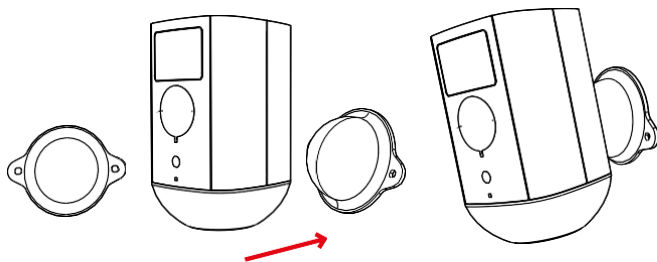

1. Place the bracket in the desired location and then screw it in place with the screws.
2. Place the camera on the magnetic mount and adjust the direction as needed.

Installing the swivel bracket

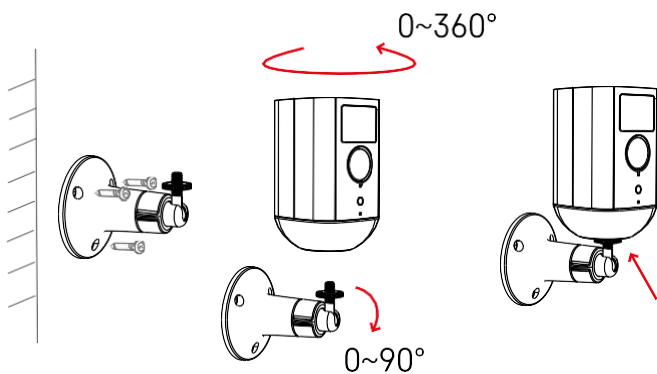

Place the bracket in the desired location and then screw it in place with the screws.

1. Place the camera on the swivel mount and adjust the direction as needed.
2. After setting the camera position, fix it with the screw.

Pairing with an app

Installing the EMOS GoSmart app



The app is available for Android and iOS via Google play and the App Store. To download the app, please scan the relevant QR code.

EMOS GoSmart mobile app

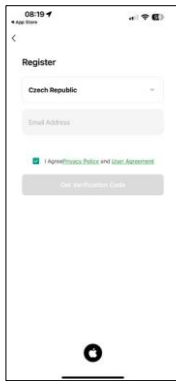
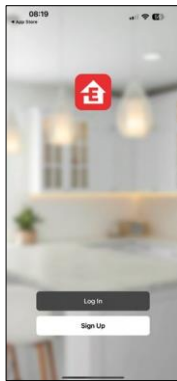
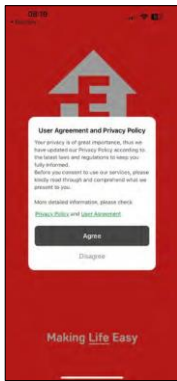

Open the EMOS GoSmart app and confirm the privacy policy and click I agree. Select the registration option. Enter the name of a valid email address and choose a password. Confirm your consent to the privacy policy. Select register.

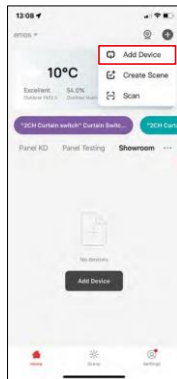
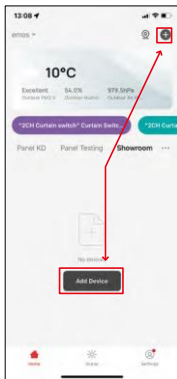

Select Add device.
Select the GoSmart product category and select the Camera IP-200 / IP-210 device.



Switch on the device by holding down the button on the top.
Reset the device using the RESET button under the rubber boot on the back of the camera. Make sure the red LED is flashing.

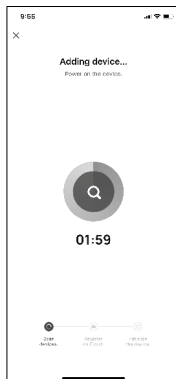
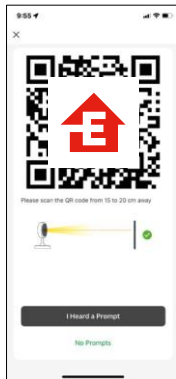

Enter the name and password of your Wi-Fi network. This information remains encrypted and is used to allow the camera to communicate with your mobile device remotely.
A QR code will appear on the display of your mobile device. Place the QR code in front of the camera lens.
Confirm that you have heard the beep for a successful pairing. The device is automatically found.
The device is located.
Confirm with the done button.

Icons and indicator lights

Description of controls in the application

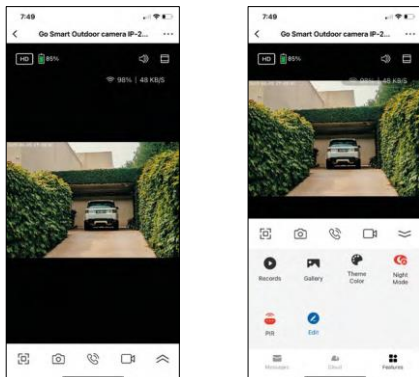

...	Advanced settings (described in more detail in the following section)
HD	Video quality switching (HD/SD)
98% 48 KB/S	Signal quality and speed
	Mute
	Zoom in
	Full screen mode
	Take pictures using the app and save them to your mobile album
	Speak
	Expand menu
	To play a video stored on an SD card
	See videos and photos taken by the app
	Light mode / dark mode
	Night mode settings. We recommend setting to AUTO.
	Motion sensor settings
	Edit icons + add control of another device
	Manage and purchase cloud storage
	Display of messages (Motion detection...)

Description of extension

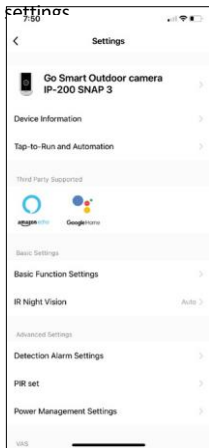

- Device information - Basic information about the device and its owner
- Tap-to-Run and Automation - View scenes and automations assigned to the device. Creation of scenes is possible directly in the main menu of the application in the section "Scenes". For H4053, this could be for example an automation where a lower sensitivity of motion detection would be set between 18:00 and 7:00.
- Basic Function Settings - Enable/disable basic control functions such as automatic screen rotation or watermarking with time and date display. Another important setting is the ability to select one-way or two-way communication.
- IR Night Vision - Night mode setting.
- Detection Alarm Settings - Alarm settings.
- Activity Area - Set the zone in which the camera captures motion. For example, if your camera is sensing a road you don't want the camera to alert you to every car that passes by, so this feature allows you to select the area that will be sensed by the motion sensor.



- Human Body Filtering - Human Body Contour Recognition. When you turn this feature on, the device should not alert you to every movement, but only when it recognizes the human body.
- PIR set - Switching on/off the motion sensor and setting its sensitivity.
- Power Management Settings - Displays the current battery status, power source, and notifies you if the battery drops below a specified percentage.
- Offline Notification - To avoid constant reminders, a notification will be sent if the device remains offline for more than 30 minutes

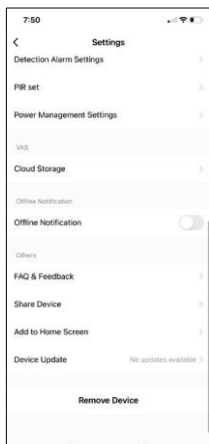

- Cloud Storage - Cloud storage settings. The cloud is not included in the box, but can be purchased additionally through the app.
- Offline Notification - To avoid constant reminders, a notification will be sent if the device remains offline for more than 30 minutes.
- FAQ & Feedback - View the most common questions along with their solutions plus the ability to send a question/suggestion/feedback directly to us
- Share Device - Share device management to another user
- Add to Home Screen - Add an icon to your phone's home screen. With this step, you don't have to open your device through the app every time, but just click directly on this added icon and it will take you straight to the camera view
- Device update - Device update. Option to enable automatic updates
- Remove Device - Remove and evaporate the device. An important step if you wish to change the owner of the device. After adding the device to the app, the device is paired and cannot be added under another account.

Controls and functions

Recording to SD card

One of the basic functions of the home security system is the SD card recording function.

The camera is battery powered, so to save battery and SD card space, it does not record continuously, but only a few seconds of footage once the PIR sensor detects motion.

The camera supports SD cards with a maximum size of 128 GB in FAT32 format. However, 32 GB SD cards are sufficient. When the SD card is full, the recordings are automatically overwritten.

Instructions on how to enable the SD card function:

1. Insert the Micro SD card into the appropriate slot under the rubber isolation on the back of the camera.
2. Open the advanced device settings and select "Storage settings".
3. Format the SD card. NOTE: Do not turn off the application or interrupt the process when formatting the SD card.
4. Switch on the PIR sensor and set the required sensitivity. In the settings there is an option to turn on/off human body recognition to prevent alarms when the camera detects, for example, the movement of an animal or a tree. Using
You can also designate an "Activity Area" where you want the camera to detect motion (for example, you don't want the camera to alert you to every car that drives down the road that the camera can see).
5. When the camera detects motion, it will also record a few seconds of footage, which can be found in  the icon:



Troubleshooting FAQ

I can't get the devices to pair. What can I do?

- Make sure you are using a 2.4GHz Wi-Fi network and have a strong enough signal
- Allow the app all permissions in the settings
- Make sure you are using the latest version of the mobile operating system and the latest version of the app

They can hear me outside but I can't hear the sound outside / I can hear the sound outside but they can't hear me.



- Make sure you have granted all permissions to the app, especially for the microphone.
- One-way communication can also be a problem. If you see this icon at the bottom: , it means that the device is set to one-way communication.
- To correct this, go to the "Basic Function Settings" menu and set "Talk mode" to "Two-way talk". This menu can be found in the extension settings (see chapter "Description of extension settings").
- The correct icon for two-way communication looks like this: 

I'm not getting notifications, why?

- Allow the app all permissions in the settings
- Turn on notifications in the app settings (Settings -> App notifications)

What SD-Card can I use?

- SD card with a maximum storage capacity of 128 GB and a minimum speed class of CLASS 10 in FAT32 format.

When the SD card memory is full, are the oldest records automatically overwritten or does the user have to manually delete them?

- Yes, the records are overwritten automatically.

Who all can use the equipment?

- Facilities must always have an admin (owner)
- Admin can share the equipment with the remaining household members and assign them rights